



Cabinet Solutions

Cafeterias • Convenience Stores
Catering • Concessions



FDWD-2X with 4-shelf multi-purpose rack
pg. 2



FSDT-1 with 4-tier circle racks, optional sign holders (signs not included) and accessory food pans
pg. 3



LFST-48-2X with 3-shelf multi-purpose rack, sign holders (signs not included) and optional Designer color
pg. 8



MVW-12-4 pg. 9



MDW-1X with standard Designer color and hood with backlit sign cut out on one side (sign included)
pg. 10



FST-1-MN shown in standard Bronze pg. 11



FSHC-6W1 with accessory food pans pg. 14



FSHC-17W1 with accessory food pans
pg. 16



FS2HAC-2PT Pass-through style with accessory food pans
pg. 18



Flav-R-Fresh® Humidified Impulse Display Cabinets

A profitable way to create impulse food sales is with the small Flav-R-Fresh® Holding and Display Cabinet. Using controlled moisturized heat allows you to showcase your product longer using minimum counter space.

- Full-view display with tempered glass sides and door
- Controlled heat and humidity for longer holding times
- Accommodates half-size sheet pans
- Revolving or stationary display racks
- Single- or reversible double-sided opening models
- Fluorescent lights illuminate the holding areas and emphasize the product



FDWD-2 with accessory 4-tier circle rack

IMPULSE CABINETS

Model* ^o	Description ^o	Dimensions W x D x H ^o	Voltage		
			Single Phase	Watts	Ship Weight
FDWD-1	1 Door w/4-Tier Circle Rack w/Motor	19 ³ / ₈ " x 20 ⁷ / ₈ " x 28 ⁵ / ₈ "	120	1390	90 lbs.
FDWD-1X	1 Door w/4-Shelf Multi-Purpose Rack w/o Motor	19 ³ / ₈ " x 20 ⁷ / ₈ " x 28 ⁵ / ₈ "	120	1390	90 lbs.
FDWD-2	2 Doors w/4-Tier Circle Rack w/Motor	19 ³ / ₈ " x 22" x 28 ⁵ / ₈ "	120	1390	90 lbs.
FDWD-2X	2 Doors w/4-Shelf Multi-Purpose Rack w/o Motor	19 ³ / ₈ " x 22" x 28 ⁵ / ₈ "	120	1390	90 lbs.

- * Models FDWD-1 and FDWD-2 include rack motor. Models with "X" designator do not have revolving display and are NOT available for retrofit.
- ^o Rack listed is included with unit. Other racks available.
- ^o Height includes standard 1" legs.
- ^o Non-humidified cabinet available. Unit will only operate in dry mode.

All Impulse Cabinet Models Feature:

Voltage: 60 Hz, 11.6 amps, NEMA 5-15P plug.

Cabinet Opening: 15³/₄"W x 19³/₄"H.

Door Hinges – Control Side and Customer Side (Two-Door Models Only): Left-hand side.

Max. Pizza Size: 15" diameter.

Water Tank Capacity for Humidity System: 1/2 gallon.

Cord Location: Facing controls, left-hand side panel, lower right corner.

ONE (1) YEAR ON-SITE PARTS AND LABOR WARRANTY, PLUS ONE (1) ADDITIONAL YEAR PARTS-ONLY WARRANTY ON ALL FLAV-R-FRESH® METAL-SHEATHED AIR HEATING ELEMENTS.

WATER QUALITY REQUIREMENTS – PAGE 19

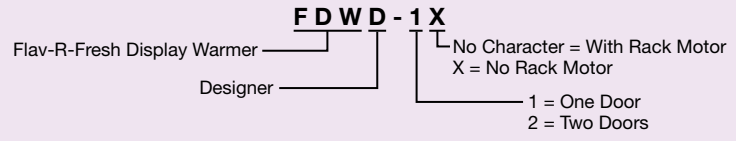

OPTIONS (available at time of purchase only)

Designer Colors – Non-standard colors are non-returnable – Clear Anodized Aluminum Standard –

RED	Warm Red
BLACK	Black
GRAY	Gray Granite
WHITE	White Granite
NAVY	Navy Blue
GREEN	Hunter Green
COPPER	Antique Copper
FDWD-SCD	Self-Closing Door in lieu of standard Door (left hinge only). Must upgrade both Doors on FDWD-2, -2X (not field reversible)
FDWD-6FRT	6" Merchandising Display Sign Holder for Control Side only (includes Metal Holder only). Available in all Designer Colors to match your unit (Black is standard). Adds 1 ¹ / ₈ " to height of unit. Requires one (1) Sign – 19 ⁵ / ₁₆ "W x 6 ³ / ₁₆ "H x 1 ¹ / ₁₆ "D (not included)
FDWD-DIS	3" One-Sided Merchandising Display Sign Holder (includes Metal Holder and Window) – one per side, three maximum. Available in all Designer Colors to match your unit (Black is standard). Adds 1 ¹ / ₄ " to height of unit. Requires one (1) Sign – 19 ¹ / ₁₆ "W x 3 ¹ / ₄ "H x 1 ¹ / ₁₆ "D (not included)
FDWD-6SIGN	6 ³ / ₈ " One-Sided Merchandising Display Sign Holder (includes Metal Holder and Window) – one per side, three maximum. Available in all Designer Colors to match your unit (Black is standard). Adds 1 ¹ / ₄ " to height of unit. Requires one (1) Sign – 19 ⁵ / ₁₆ "W x 6 ¹ / ₄ "H x 1 ¹ / ₁₆ "D (not included)

ACCESSORIES (available for purchase at any time)

FDWD-LEGS	4" Adjustable Legs (4"-5")
COUPLING	Motorless Rack Coupling for FDWD-1X and FDWD-2X models (select Circle Rack or Pretzel Tree)
FDWD4TCRR	4-Tier Circle Rack with Pizza Pan Retainers (requires Coupling for -1X or -2X models)
FDW4SMP	4-Shelf Multi-Purpose Rack (each shelf – 13 ³ / ₈ "W x 12 ⁵ / ₈ "D)
FDW3TPT	3-Tier Pretzel Tree (requires Coupling for -1X or -2X models)

DECORATIVE KIT – PAGE 5

RACKS – PAGE 6

FOOD PANS AND TRIVETS – PAGE 19

COLORS AND FINISHES – PAGE 19



COUPLING Accessory

Flav-R-Savor® Humidified Holding & Display Cabinets

Balancing a precise combination of heat and humidity, the Hatco Flav-R-Savor® Cabinets provide an attractive showcase for hot food displays and generate impulse sales. A complete range of cabinet sizes, door options and rack types allows for perfect merchandising of food products such as pizza, fried foods, bakery items, sandwiches and more.

- Full-view display with tempered glass sides and door provide maximum heat retention
- Controlled heat and humidity for longer holding times
- ¾ gallon stainless water reservoir provides all day moisture
- Low-water protection prevents heating element burnout and alerts operator to low-water condition
- Revolving or stationary display racks
- Available in two heights with single-sided or double-sided openings
- Fluorescent lights with clear plastic cover help showcase food product



FSD-1 with 3-tier circle rack and optional mechanical controls



FSDT-2 with 4-tier circle rack, 4" legs, optional *Designer Black* color and accessory food pans

DISPLAY CABINETS

Model* ^o	Description ^o	Dimensions W x D x H	Voltage Single Phase	Ship Weight
Standard				
FSD-1	1 Door w/3-Tier Circle Rack w/Motor	22½" x 24½" x 27½"	120	110 lbs.
FSD-1X	1 Door w/3-Tier Pan Rack w/o Motor	22½" x 24½" x 27½"	120	110 lbs.
FSD-2	2 Doors w/3-Tier Circle Rack w/Motor	22½" x 25¾" x 27½"	120	114 lbs.
FSD-2X	2 Doors w/3-Tier Pan Rack w/o Motor	22½" x 25¾" x 27½"	120	112 lbs.
Tall				
FSDT-1	1 Door w/4-Tier Circle Rack w/Motor	22½" x 24½" x 32½"	120	118 lbs.
FSDT-1X	1 Door w/4-Tier Pan Rack w/o Motor	22½" x 24½" x 32½"	120	118 lbs.
FSDT-2	2 Doors w/4-Tier Circle Rack w/Motor	22½" x 25¾" x 32½"	120	122 lbs.
FSDT-2X	2 Doors w/4-Tier Pan Rack w/o Motor	22½" x 25¾" x 32½"	120	114 lbs.

- * Models FSD-1, FSD-2, FSDT-1 and FSDT-2 include rack motor. Models with "X" designator do not have revolving display and are NOT available for retrofit.
- ^o Rack listed is included with unit. Other racks available.
- ^o Non-humidified cabinet available. Unit will only operate in dry mode.

All Display Cabinet Models Feature:

Voltage: 60 Hz, 1440 watts, 12.0 amps, NEMA 5-15P plug.

Cabinet Opening Dimensions: Standard Models: 19"W x 18½"H.

Tall Models: 19"W x 23¾"H.

Door Hinges: Control Side: Left-hand side.

Customer Side (Two-Door Models Only): Right-hand side.

Max. Pan Size: 19" diameter.

Water Tank Capacity for Humidity System: ¾ gallon.

Cord Location: Facing controls, left-hand side panel, lower right corner.

OPTIONS AND ACCESSORIES – PAGE 4

DECORATIVE KIT – PAGE 5

RACKS – PAGE 6

WATER QUALITY REQUIREMENTS – PAGE 19

ONE (1) YEAR ON-SITE PARTS AND LABOR WARRANTY, PLUS ONE (1) ADDITIONAL YEAR PARTS-ONLY WARRANTY ON ALL FLAV-R-SAVOR® METAL-SHEATHED AIR HEATING ELEMENTS.

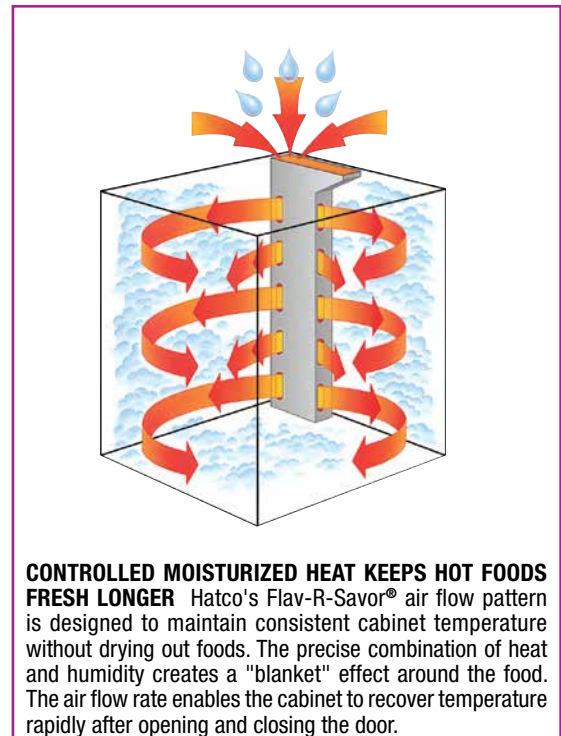
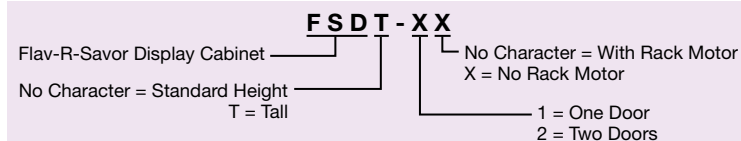



Two FSDT-1 with 4-tier circle racks, optional sign holders (signs not included) and accessory food pans

OPTIONS (available at time of purchase only)

Designer Colors – Non-standard colors are non-returnable – Clear Anodized Aluminum Standard –

RED	Warm Red
BLACK	Black
GRAY	Gray Granite
WHITE	White Granite
NAVY	Navy Blue
GREEN	Hunter Green
COPPER	Antique Copper
THERM	Mechanical Controls
FSD7SIGN	7½" Merchandising Display Sign Holder (includes Metal Holder and Window) – one per side , three maximum. Available in all <i>Designer Colors</i> to match your unit (Black is standard). Adds 1¼" to height of unit. Requires one (1) Sign – 22½"W x 7½"H x ¼"D (not included)

ACCESSORIES (available for purchase at any time)

F-LEGS-4	4" Adjustable Legs
COUPLING	Motorless Rack Coupling for FSD-1X, FSD-2X, FSDT-1X and FSDT-2X models (select appropriate Circle Rack or Pretzel Tree)
Racks – FSD only –	
FSD5SMP	5-Shelf Multi-Purpose Rack (each shelf – 18"W x 16"D)
FSD3TCR	3-Tier Circle Rack with Pizza Pan Retainers (requires Coupling for -1X or -2X models)
FSD3TPR	3-Tier Pan Rack (accommodates Half-Size Sheet Pans – not included)
Racks – FSDT only –	
FSDT7SMP	7-Shelf Multi-Purpose Rack (each shelf – 18"W x 16"D)
FSDT4TCR	4-Tier Circle Rack with Pizza Pan Retainers (requires Coupling for -1X or -2X models)
FSDT5TCR	5-Tier Circle Rack with Pizza Pan Retainers (requires Coupling for -1X or -2X models)
FSDT4TPR	4-Tier Pan Rack (accommodates Half-Size Sheet Pans – not included)
FSDT3SAR	3-Shelf Angle Rack (15° angle shelves). Each shelf – 18" x 16¼"
FSDT3TPT	3-Tier Pretzel Tree (requires Coupling for -1X or -2X models)

DECORATIVE KIT – PAGE 5

RACKS – PAGE 6

FOOD PANS AND TRIVETS – PAGE 19

COLORS AND FINISHES – PAGE 19

Flav-R-Savor® Decorative Kit for FDWD, FSD, FSDT models only

Transform your Hatco Flav-R-Savor® Holding & Display Cabinet from a "heated box" into a *Designer Merchandiser* with a variety of simple accessory additions. Create a new look and feel to your decór.

- The curved hinged header allows easy access to controls and water fill cup, and gives a great area to brand your food product with a magnetic sign (sign not included)
- All decorative pieces come standard in *Designer* Black powdercoat, with additional *Designer* colors available
- Curved inset panels enhance the overall look
- The base skirt completes the transformation and gives an additional branding area. Available in flat or curved panels for front and/or back of unit
- Signs not included



FSDT-1 with 4-tier circle rack and full Decorative Kit (signs not included)

OPTIONS (available at time of purchase only – additional lead time required)

Designer Colors – Non-standard colors are non-returnable – Black Standard –

RED	WR	Warm Red
BLACK	BK	Black
GRAY	GG	Gray Granite
WHITE	WG	White Granite
NAVY	NB	Navy Blue
GREEN	HG	Hunter Green
COPPER	AC	Antique Copper

ACCESSORIES (available for purchase at any time)

Side Insets – Must choose Designer Color – Black Standard –

FSD-INSET1 ②	Two (2) Crescent Inset Panels for FSD models
FSD-INSET2 ②	Two (2) Wave Inset Panels for FSD models
FSDT-INSET1 ②	Two (2) Crescent Inset Panels for FSDT models
FSDT-INSET2 ②	Two (2) Wave Inset Panels for FSDT models
FDWD-INSET1 ②	Two (2) Crescent Inset Panels for FDWD models
FDWD-INSET2 ②	Two (2) Wave Inset Panels for FDWD models

Top Covers – Must choose Designer Color – Black Standard –

FSD-CTLH ①	Curved Hinged Header on control side for FSD and FSDT models
FDWD-CTLH ①	Curved Hinged Header on control side for FDWD models
FSD-CUSH ②	Curved Header on non-control side for FSD and FSDT models
FDWD-CUSH ②	Curved Header on non-control side for FDWD models

Base Skirts – Requires 4" Adjustable Legs (not included) – Must choose Designer Color – Black Standard –

FSD-SQB ③④⑦	One (1) Flat Front Panel, two (2) Flat Side Panels and one (1) Flat Back Panel for FSD and FSDT models
FDWD-SQB ③④⑦	One (1) Flat Front Panel, two (2) Flat Side Panels and one (1) Flat Back Panel for FDWD models
FSD-1CB ③④⑦	One (1) Curved Front Panel, two (2) Flat Side Panels and one (1) Flat Back Panel for FSD and FSDT models
FDWD-1CB ③④⑦	One (1) Curved Front Panel, two (2) Flat Side Panels and one (1) Flat Back Panel for FDWD models
FSD-2CB ③④④	One (1) Curved Front Panel, two (2) Flat Side Panels and one (1) Curved Back Panel for FSD and FSDT models
FDWD-2CB ③④④	One (1) Curved Front Panel, two (2) Flat Side Panels and one (1) Curved Back Panel for FDWD models
F-LEGS-4	4" Adjustable Legs for FSD and FSDT models
FDWD-LEGS	4" Adjustable Legs for FDWD models

COLORS AND FINISHES – PAGE 19

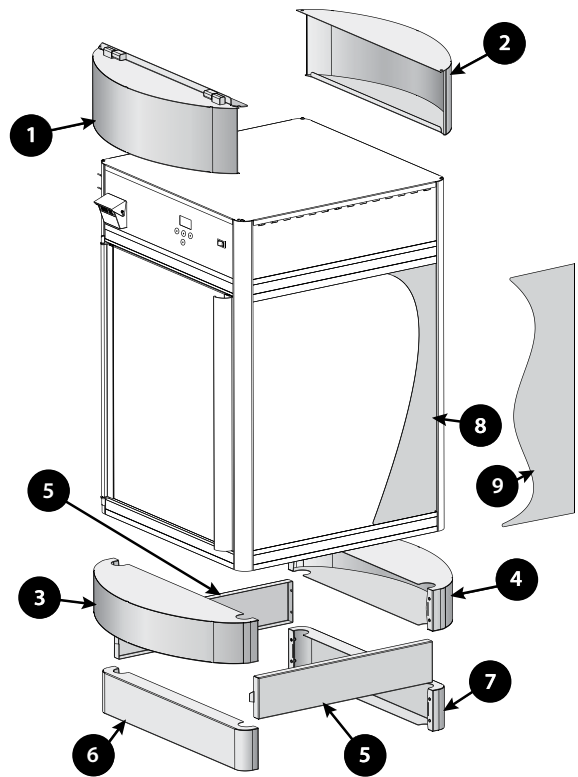



Display Rack Selections

Racks For FDWD Models (Page 2)

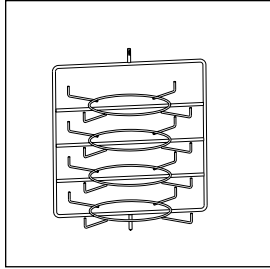

**4-Tier Circle Rack
FDWD4TCRR**
(Max. 15" dia. pans)
(3¼" opening)

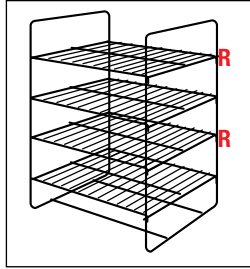

**4-Shelf Multi-Purpose
Rack FDW4SMP**
(Max. 18" x 13" Half-Size
Sheet Pans – FDWD-2X
only) (3¼" opening)

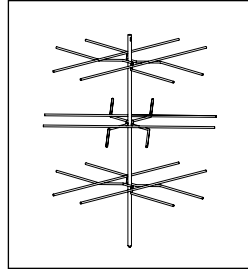

**3-Tier Pretzel Tree
FDW3TPT**
(5⅞" opening)

Racks For FSD Models (Page 3)

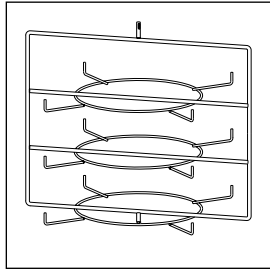

**3-Tier Circle Rack
FSD3TCR**
(4⅝" opening)

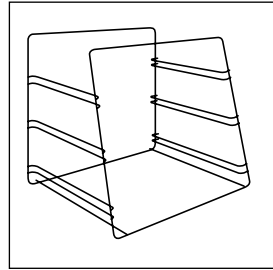

**3-Tier Pan Rack
FSD3TPR**
(3½" opening)

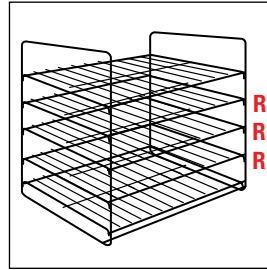

**5-Shelf Multi-Purpose
Rack FSD5SMP**
(2½" opening)

Racks For FSDT Models (Page 3)

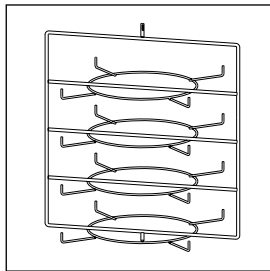

**4-Tier Circle Rack
FSDT4TCR**
(Max. 19" dia. pans)
(4⅝" opening)

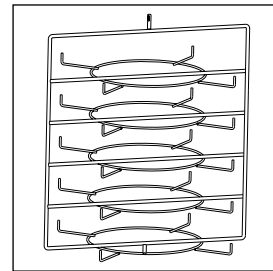

**5-Tier Circle Rack
FSDT5TCR**
(Max. 19" dia. pans)
(3⅞" opening)

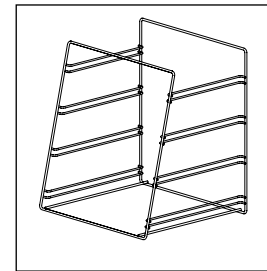

**4-Tier Pan Rack
FSDT4TPR**
(Max. 18" x 13" Half-Size
Sheet Pans) (3½" opening)

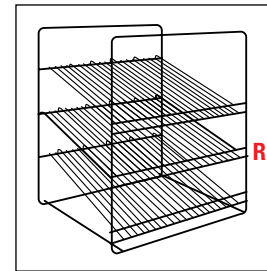

**3-Shelf Angle Rack
FSDT3SAR**
(3½" opening)

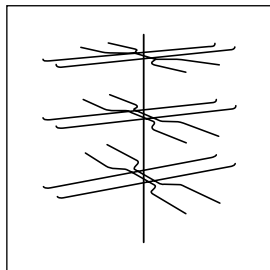

**3-Tier Pretzel Tree
FSDT3TPT**
(5⅞" opening)

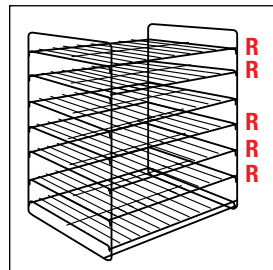

**7-Shelf Multi-Purpose Rack
FSDT7SMP**
(Max. 18" x 13" Half-Size
Sheet Pans) (2½" opening)

R Removable Shelves

Flav-R-Savor® Humidified Large Capacity Display Cabinets

Hatco Large Capacity Holding Cabinets hold more product at proper serving temperatures than standard size models. This allows for food to be prepared in advance of peak serving periods, while placing product in full-view cabinets to increase impulse sales.

- Full-view display with tempered glass sides and incandescent lights to illuminate holding area
- Multi-purpose display racks included
- Optional self-closing sliding doors for self-serve applications



WFST-1X with a 4-shelf multi-purpose rack (decals and food pans not included)

- Seven (7) optional *Designer* colors are available – non-standard colors are non-returnable
- Self-closing sliding doors, self-closing French doors, halogen bulbs and 4" adjustable legs available



WFST-2X with a 4-shelf multi-purpose rack, optional *Designer* color, self-closing sliding doors, and accessory food pans and 4" legs

WIDE HOLDING CABINETS

Model	Bulbs	Description	Dimensions W x D x H	Voltage	Watts	Amps	Plugs [▲]	Ship Weight
WFST-1X	4	2 Doors w/4-Shelf Rack	32 ¹ / ₈ " x 25 ¹ / ₄ " x 32 ³ / ₄ "	120	1790	14.9	NEMA 5-15P	182 lbs.
WFST-2X	4	4 Doors w/4-Shelf Rack	32 ¹ / ₈ " x 27 ⁵ / ₈ " x 32 ³ / ₄ "	120	1790	14.9	NEMA 5-15P	188 lbs.

▲ Canadian models use NEMA 5-20P.

All Wide Holding Cabinet Models Feature:

Cabinet Opening Dimensions: 28"W x 21¹/₈"H.

Available Shelf Space: 26¹/₄"W x 19³/₄"D. Holds one (1) full-size sheet pan per shelf.

Water Tank Capacity for Humidity System: ³/₄ gallon.

Cord Location: Facing controls, left-hand side panel, lower right corner.

WATER QUALITY REQUIREMENTS – PAGE 19

OPTIONS (available at time of purchase only)

Designer Colors – Non-standard colors are non-returnable – Clear Anodized Aluminum Standard –

RED	Warm Red
BLACK	Black
GRAY	Gray Granite
WHITE	White Granite
NAVY	Navy Blue
GREEN	Hunter Green
COPPER	Antique Copper
1SLIDE-DR	Self-Closing Sliding Doors in lieu of standard Hinged Doors on one side only (WFST-2X only)
FRSELFCL	Self-Closing French Doors
HAL	Halogen Bulb in lieu of standard Display Light (60 Watt) – unit accommodates four (4) Bulbs

ACCESSORIES (available for purchase at any time)

FSTCR-LEG 4" Adjustable Legs

FOOD PANS AND TRIVETS – PAGE 19

COLORS AND FINISHES – PAGE 19

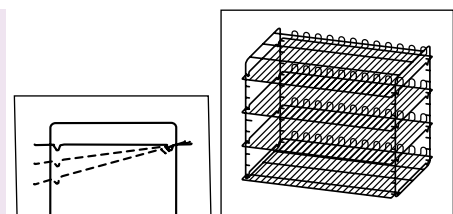

**WFST 4-Shelf
Multi-Purpose Rack**
Adjustable shelves
in 2" increments

ONE (1) YEAR ON-SITE PARTS AND LABOR WARRANTY, PLUS ONE (1) ADDITIONAL YEAR PARTS-ONLY WARRANTY ON ALL FLAV-R-SAVOR® METAL-SHEATHED AIR HEATING ELEMENTS.

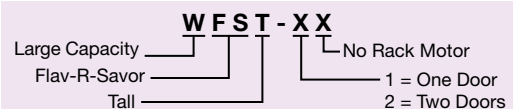



Flav-R-Savor® Non-Humidified Large Capacity Display Cabinets

When capacity is an issue, Hatco's Large Capacity Holding Cabinet is perfect for wrapped or bagged product. Designed to hold prepared foods for prolonged periods of time, while maintaining that "just-made" quality, allows for advanced preparation of peak serving periods.

- Countertop cabinets with self-closing French-style glass doors
- Standard sign holders on all four sides of the cabinet (signs not included)
- Full-view display with tempered glass sides and incandescent lights to illuminate holding area
- Multi-purpose display rack included
- Perfect for large quantities of wrapped or boxed food
- Optional *Designer* colors available – non-standard colors are non-returnable
- Holds two (2) standard sheet pans side-by-side on three shelves for increased product visibility and easy accessibility

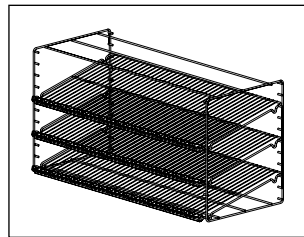

LFST 3-Shelf Multi-Purpose Rack with adjustable shelves in 2" increments

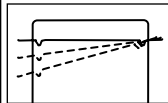

LFST-48-2X with a 3-shelf multi-purpose rack, sign holders (signs not included) and optional *Designer* color

LARGE CAPACITY HOLDING CABINETS - NON-HUMIDIFIED

Model*	Bulbs	Description	Dimensions W x D x H	Plug	Ship Weight
LFST-48-1X	6	Front Glass, Back French Doors	48 $\frac{7}{8}$ " x 25 $\frac{3}{8}$ " x 30"	NEMA L14-20P	222 lbs.
LFST-48-2X	6	Front and Back French Doors	48 $\frac{7}{8}$ " x 27 $\frac{1}{8}$ " x 30"	NEMA L14-20P	230 lbs.

* When no color is specified, unit will be Black.

All Non-Humidified Large Capacity Holding Cabinet Models Feature:

Voltage: 120/208-240, 2150 watts, 14.6 amps.

Cabinet Opening Dimensions: 44"W x 22"H.

Available Shelf Space: 41 $\frac{3}{4}$ "W x 17"D. Holds three (3) half-size sheet pans per shelf.

Cord Location: Facing controls, left-hand side panel, lower right corner.

OPTIONS (available at time of purchase only)

Designer Colors – Non-standard colors are non-returnable – Black Standard –

RED	Warm Red
GRAY	Gray Granite
WHITE	White Granite
NAVY	Navy Blue
GREEN	Hunter Green
COPPER	Antique Copper
HAL	Halogen Bulb in lieu of standard Display Light (60 Watt)

FOOD PANS AND TRIVETS – PAGE 19
COLORS AND FINISHES – PAGE 19

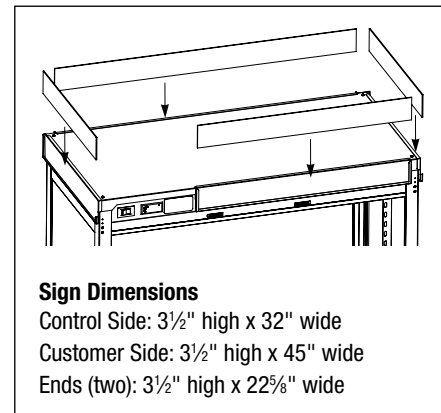

Sign Dimensions

Control Side: 3 $\frac{1}{2}$ " high x 32" wide

Customer Side: 3 $\frac{1}{2}$ " high x 45" wide

Ends (two): 3 $\frac{1}{2}$ " high x 22 $\frac{5}{8}$ " wide

LFST Cabinet comes with sign holders attached on all four sides, with clear plastic inserts (signs not included)

ONE (1) YEAR ON-SITE PARTS AND LABOR WARRANTY, PLUS ONE (1) ADDITIONAL YEAR PARTS-ONLY WARRANTY ON ALL FLAV-R-SAVOR® METAL-SHEATHED AIR HEATING ELEMENTS.

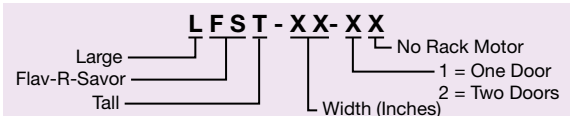

Mini Vertical Warmer

Our answer to impulse point-of-sale demands. Hatco's patented Mini Vertical Warmer is small enough to set anywhere, keeping pre-packaged snacks warm, appealing and at your customer's fingertips. There's nothing better than a warm treat!

- Ability to connect up to eight (8) units side-by-side, while only utilizing one outlet connection
- Clear polycarbonate hinged cover lets you see product levels at a glance
- Adjustable thermostat on back of unit
- Accessory wall mount bracket saves on counter space and draws attention at eye level
- Great for merchandising warm snacks
- For pre-packaged, non-hazardous foods



MVW-12-4 shown with standard *Designer Black* exterior, optional *Designer Black* internal coating and two (2) accessory **MVW-JUMPERPLUG** to connect units together



MVW-12-4 with standard *Designer Black* exterior

MINI VERTICAL WARMER

Model	Dimensions W x D x H	Voltage Single Phase	Watts	Plug	Ship Weight
MVW-12-4	5 7/8" x 8" x 16 7/8"	120	150	NEMA 5-15	18 lbs.

All Mini Vertical Warmer Models Feature:
Cord Location: Server's side, bottom right.

OPTIONS (available at time of purchase only)

Designer Color for Interior – Non-standard colors are non-returnable – Clear Anodized Aluminum Standard –
BLACK Black

ACCESSORIES (available for purchase at any time)

MVW-INSERT	4" wide Insert to adjust dispensing height
MVW-WALLMOUNT	Wall-Mounting Bracket in standard <i>Designer Black</i> with Toggle Bolts for drywall and Wood Screws for stud walls
MVW-JUMPERPLUG	24" Jumper Plug to connect two (2) units

COLORS AND FINISHES – PAGE 19



MVW-WALLMOUNT
Accessory

ONE (1) YEAR ON-SITE PARTS AND LABOR WARRANTY.

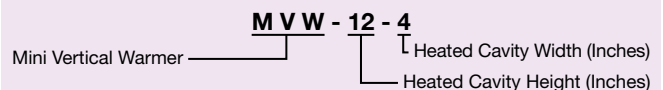



Non-Humidified Mini Display Warmers

The Hatco Mini Display Warmer is perfect for cookies, pastries, wrapped or boxed sandwiches or any other product that does not require humidity. Hot air circulates throughout the entire cabinet, keeping food at safe serving temperatures. The small footprint takes up little of your valuable counterspace while merchandising your breakfast, lunch or dinner offerings.

- Magnetically adjustable shelves allow horizontal or slanted displays
- Tempered glass sides and incandescent light
- Available as a 1- or 2-door pass-through model
- Doors may be field converted to any side
- Optional black hood with backlit graphic sign cutout that can be rotated in field to face any side (sign included)



MDW-1X with standard Designer color and optional hood with backlit sign cut out on one side (sign included)

MINI DISPLAY WARMERS - NON-HUMIDIFIED

Model	Description	Dimensions W x D x H	Voltage	Watts	Amps	Plug	Ship Weight
MDW-1X	1 Door w/3 Shelves	15¾" x 17" x 25½"	120	470	3.9	NEMA 5-15	46 lbs.
MDW-2X	2 Doors w/3 Shelves	15¾" x 18¾" x 25½"	120	470	3.9	NEMA 5-15	53 lbs.

All Mini Display Warmer Models Feature:

Cabinet Opening Dimensions: 12½"W x 15½"H.

Door Hinges: Control Side: Left-hand side.

Customer Side (Two-Door Models Only): Right-hand side.

Cord Location: Facing controls, lower right corner.

OPTIONS (available at time of purchase only)

Designer Color for Posts, Base and Top Trim – Non-standard colors are non-returnable – Black Standard –

RED	Warm Red
GRAY	Gray Granite
WHITE	White Granite
NAVY	Navy Blue
GREEN	Hunter Green
COPPER	Antique Copper
BCKLIT-MDW	Hood with Backlit Sign cut out on one side – Black only (Sign included)

COLORS AND FINISHES – PAGE 19

ONE (1) YEAR ON-SITE PARTS AND LABOR WARRANTY, PLUS ONE (1) ADDITIONAL YEAR PARTS-ONLY WARRANTY ON ALL MINI DISPLAY WARMER METAL-SHEATHED AIR HEATING ELEMENTS.

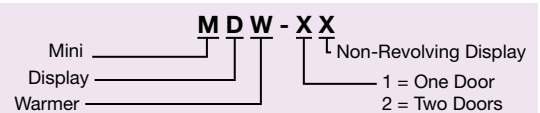

Non-Humidified Macho Nacho® Chip Warmers

Keep your nacho chips hot, fresh and crisp with Hatco's Macho Nacho® Chip Warmer. This highly-visible heated merchandiser circulates air to prevent the loss of natural oils, eliminating the need to frequently replace stale chips.

- Keeps chips hot, fresh and crisp longer, reducing refill time and minimizing waste
- Specialty cabinets to hold and/or merchandise bulk nacho chips
- Special ductwork forces dry heat through chips from the bottom up
- Special two-door access for easy loading and serving
- 25 lb. or 40 lb. capacity
- Shatter-resistant incandescent lights illuminate the holding areas and emphasize the product



FDWD-1-MN



FST-1-MN shown in standard Bronze

CHIP WARMERS - NON-HUMIDIFIED

Model	Dimensions W x D x H	Product Capacity	Voltage	Watts	Plug	Ship Weight
FDWD-1-MN	19 ³ / ₈ " x 23 ³ / ₈ " x 28 ³ / ₄ "	25 lbs.	120	1080	NEMA 5-15P	101 lbs.
FST-1-MN	22 ⁷ / ₆ " x 27" x 32 ³ / ₄ "	40 lbs.	120	1245	NEMA 5-15P	132 lbs.

All Chip Warmer Models Feature:

Cabinet Opening: FDWD-1-MN: Upper Door: 16³/₈"W x 9¹/₂"H.

Lower Door: 16³/₈"W x 9"H.

FST-1-MN: Upper Door: 18³/₈"W x 11¹/₄"H.

Lower Door: 18³/₈"W x 9⁷/₈"H.

Decal Size: FDWD-1-MN: 16³/₈"W x 5¹/₂"H.

FST-1-MN: 18³/₈"W x 6"H.

Cord Location: Facing controls, left-hand side panel, lower right corner.

ONE (1) YEAR ON-SITE PARTS AND LABOR WARRANTY, PLUS ONE (1) ADDITIONAL YEAR PARTS-ONLY WARRANTY ON ALL MACHO NACHO® METAL-SHEATHED AIR HEATING ELEMENTS.

XXXX - 1 - MN

FDWD = 25 lb. Chip Capacity
FST = 40 lb. Chip Capacity

Macho Nacho Unit
Single-Side Opening



Flav-R-Savor® Tall Non-Humidified Holding Cabinets

Be prepared to serve ready-to-go pizzas with Hatco's Flav-R-Savor® Tall Dry Holding Cabinets. An eight-shelf rack with 5" centers will hold a maximum of sixteen (16) boxed (18" Sq x 2⁵/₁₆" H maximum) or eight (8) bagged pizzas.

- Great for boxed or bagged carryout pizzas
- Tempered glass throughout for excellent visibility, improving product rotation
- Even, constant cabinet temperatures with no humidity
- Two (2) 60 watt bulbs at the back top of the unit to illuminate product
- Units come with an eight-shelf rack, six of which are removable



PFST-2X with standard stainless steel 8-shelf rack



PFST-1XB with standard Smooth White 8-shelf rack

TALL HOLDING CABINETS - NON-HUMIDIFIED

Model	Description	Dimensions W x D x H	Opening Dimensions W x H	Voltage	Watts	Plug ^	Ship Weight
Standard							
PFST-1X	1 Door	22 ⁷ / ₈ " x 25" x 57"	18 ³ / ₄ " x 40 ³ / ₈ "	120	1767	NEMA 5-15P	200 lbs.
PFST-2X	2 Doors	22 ⁷ / ₈ " x 27 ¹ / ₄ " x 57"	18 ³ / ₄ " x 40 ³ / ₈ "	120	1767	NEMA 5-15P	207 lbs.
With Base							
PFST-1XB	1 Door	24 ³ / ₄ " x 25 ¹ / ₂ " x 70"	18 ³ / ₄ " x 40 ³ / ₈ "	120	1767	NEMA 5-15P	258 lbs.

^ Canadian models use NEMA 5-20P.

All Tall Non-Humidified Holding Cabinet Models Feature:

Models Shipped with: PFST-1X, -2X: Stainless steel body, an eight-shelf rack with six (6) removable shelves in standard stainless steel, a new latching handle, 5" locking casters and a cord & plug set.

PFST-1XB: Solid back panel, stainless steel inside (with painted Glossy Gray on the outside), an eight-shelf rack with six (6) removable shelves in standard Smooth White, front and side sign holders painted Glossy Gray with flip-up side for access to controls (signs not included), 11" high Designer Black base, a latching handle, 4" locking casters and a cord & plug set.

Available Shelf Space: 18" square x 4⁵/₈" height.

Cord Location: Facing controls, left-hand side panel, lower right corner.

OPTIONS (available at time of purchase only)

Designer Color – Non-standard colors are non-returnable – Clear Anodized Aluminum Standard – BLACK Black



COLORS AND FINISHES – PAGE 19

ONE (1) YEAR ON-SITE PARTS AND LABOR WARRANTY, PLUS ONE (1) ADDITIONAL YEAR PARTS-ONLY WARRANTY ON ALL FLAV-R-SAVOR® METAL-SHEATHED AIR HEATING ELEMENTS.



Flav-R-Savor® Portable Holding Cabinets

Hatco's energy efficient Flav-R-Savor® Portable Holding Cabinets will keep prepared foods at optimum serving temperatures for hours. The thermostatically-controlled heat and humidity allows food to be prepared in advance of peak serving periods.



FSHC-7W1-EE &
FSHC-7W2-EE
(120V models only)
NOTE: Units equipped
with a heavy-duty
glass door(s) are not
ENERGY STAR qualified

- Allows you to hold product longer while saving you money through increased energy efficiencies
- Electronic control with digital read out, temperature range of 80°- 200°F and humidity controller
- The lower temperature range of 80°-100°F can be used for proofing all types of breads
- All stainless steel interior
- No heating element in direct contact with water makes the unit easier to clean
- Accommodates Gastronorm pans
- Electrical components, controls and digital temperature readout are located at the top for easy access
- Comes in standard *Designer* Black or optional Stainless Steel – non-standard colors are non-returnable
- Stacking kit available
- Doors are field convertible from left to right



FSHC-7W1-EE shown in *Designer* Black, with optional bumper kit and right-hand hinged door

PORTABLE ENERGY EFFICIENT HOLDING CABINETS

Model	Description	Dimensions			Voltage	Hz	Watts	Amps	Plug	Ship Weight
		W x D x H								
FSHC-5W1-EE	Single Door	26½"	x 31¼"	x 36"	120	60	1118	9.3	NEMA 5-15P	212 lbs.
FSHC-7W1-EE	Single Door	26½"	x 31¼"	x 39"	120	60	1118	9.3	NEMA 5-15P	222 lbs.
FSHC-7W2-EE	2-Door Pass-Through	26½"	x 34¾"	x 39"	120	60	1118	9.3	NEMA 5-15P	232 lbs.

All Portable Energy Efficient Holding Cabinet Models Feature:

Interior Cabinet Capacity: 20¾"W x 26¾"D.

Top Surface Dimensions: 25¾"W x 28½"D.

Models Shipped with: A 6" cord and plug set, 4" diameter casters (with 5½" clearance), stainless steel heavy-duty door with left-hand door hinge and adjustable rack slides (seven [7] for the -7WX-EE units, and five [5] for the -5W1-EE unit).

Pan Capacity: -5WX-EE: Ten (10) full-sized sheet pans or 2/1 Gastronorm pans on 1½" spacing; five (5) full-sized sheet pans or 2/1 Gastronorm pans on 3¼" spacing; ten (10) full-sized hotel pans or 1/1 Gastronorm pans on 1½" spacing.

-7WX-EE: Fourteen (14) full-sized sheet pans* or 2/1 Gastronorm pans on 1½" spacing; seven (7) full-sized sheet pans or 2/1 Gastronorm pans on 2¾" spacing; fourteen (14) hotel sized pans or 1/1 Gastronorm pans on 1½" spacing.

Water Tank Capacity for Humidity System: 1 gallon.

Cord Location: Back of unit, upper right side.

* With purchase of extra pan slides.

WATER QUALITY REQUIREMENTS – PAGE 19

ONE (1) YEAR ON-SITE PARTS AND LABOR WARRANTY, PLUS ONE (1) ADDITIONAL YEAR PARTS-ONLY WARRANTY ON ALL FLAV-R-SAVOR® METAL-SHEATHED AIR HEATING ELEMENTS.

OPTIONS (available at time of purchase only)

Colors (Side Panels) – Non-standard colors are non-returnable – Black standard –
SS Stainless Steel

Colors (Top) – Non-standard colors are non-returnable – Black standard –
SS Stainless Steel

EE-GLASS Glass Door in lieu of Stainless Steel Door (is not Energy Star qualified)

EE-LPCAST Low Profile Casters – FSHC-5W1-EE model only (deduct 2¼" from height)

EE-PLATFORM Platform for mounting directly on a counter in lieu of Casters (deduct 4½" from height)

EE-STACK-BLK *Designer* Black Stacking Hardware mounted to bottom of Cabinet for two (2) FSHC-7W1 or two (2) FSHC-5W1 units in lieu of Casters (cannot have Legs on lower unit)

EE-STACK-SS Stainless Steel Stacking Hardware mounted to bottom of Cabinet for two (2) FSHC-7W1 or two (2) FSHC-5W1 units in lieu of Casters (cannot have Legs on lower unit)

EE-BUMPER Bumper Hardware – only for use with standard Casters (add ½" to height)

EE-4LEGS 4" Legs in lieu of Casters (deduct ½" from height)

EE-6LEGS 6" Legs in lieu of Casters (add 1¼" to height)

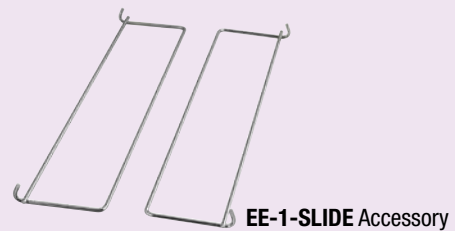

EE-1-SLIDE Accessory



ACCESSORIES (available for purchase at any time)

EE-1-SLIDE Extra Pan Slides

FOOD PANS AND TRIVETS – PAGE 19

COLORS AND FINISHES – PAGE 19

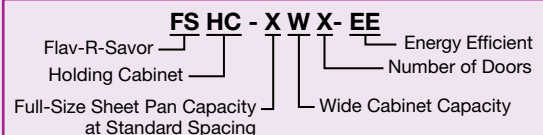



Flav-R-Savor® Low Profile, Humidified, Portable Holding Cabinets

Prepare food in advance of peak serving periods and safely hold it at optimum serving temperatures with the Flav-R-Savor® Portable Holding Cabinet. Thermostatically-controlled heat and humidity allows you to hold product for hours.

- Thermostatically-controlled heat and humidity holds hot food at optimum serving temperatures longer

- Allows preparation of food in advance of peak serving periods
- Accommodates Gastronorm pans
- Electrical components, controls, water reservoir and digital temperature readout are located at the top for easy access
- Reduced height – less than 30" high, and wider footprint for increased capacity
- Insulated side walls, field reversible glass doors, large swivel casters with wheel locks and 6" recessed cord & plug set are standard
- Stacking kit available



FSHC-6W1 with accessory food pans

LOW PROFILE HOLDING CABINETS – HUMIDIFIED

Model	Description	Dimensions (W x D x H) <i>Height includes standard casters</i>	Plug	Ship Weight
FSHC-6W1	1 Door	25½" x 29¾" x 32½"	NEMA 5-15P	167 lbs.
FSHC-6W2*	2 Doors	25½" x 32" x 32½"	NEMA 5-15P	180 lbs.

* FSHC-6W2 is a two-door pass-through single cabinet, not two units stacked.

All Low Profile Holding Cabinet Models Feature:

Voltage: 120, 60 Hz, 1697 watts, 14.1 amps, NEMA 5-15P (Canadian models use NEMA 5-20P).

Cabinet Opening Dimensions: 21½"W x 19"H.

Top Surface Dimensions: 25¾"W x 25¾"D.

Models Shipped with: A 6' cord & plug set, 4" diameter casters (with 5/8" clearance) and six (6) sets of adjustable angle slides.

Pan Capacity: Six (6) 18"W x 26"D sheet pans or six (6) ¾ Gastronorm pans on 3" centers; eleven (11) 18"W x 26"D sheet pans* or eleven (11) 2/1 Gastronorm pans on 1½" centers*; or twelve (12) 20"W x 12"D x 2½"H hotel pans*.

Water Tank Capacity for Humidity System: ¾ gallon.

Cord Location: Back of unit, upper right side.

* With purchase of extra pan slides.

WATER QUALITY REQUIREMENTS – PAGE 19

OPTIONS (available at time of purchase only)

Colors (Side Panels) – Non-standard colors are non-returnable – Silver Gray Standard –

BLACK	Designer Black
SS	Stainless Steel

Colors (Top) – Non-standard colors are non-returnable – Silver Gray Standard –

BLACK	Designer Black
SS	Stainless Steel

6W-SS-DR Stainless Steel Door in lieu of Glass Door

HD-SS-DR Heavy-Duty Stainless Steel Door with Positive Latch Handle

6W1-LPCAST 2" Low Profile Locking Casters in lieu of standard Casters (2" diameter with 3" clearance – overall height is 29¾")

6W1-STACK Silver Gray Stacking Hardware mounted to top of Cabinet for two (2) FSHC-6W1 units in lieu of Casters

CORDWIND Bracket for holding Cord during transport

ACCESSORIES (available for purchase at any time)

6W1-SLIDE Extra Pan Slides

FOOD PANS AND TRIVETS – PAGE 19 COLORS AND FINISHES – PAGE 19



6W1-SLIDE
Accessory

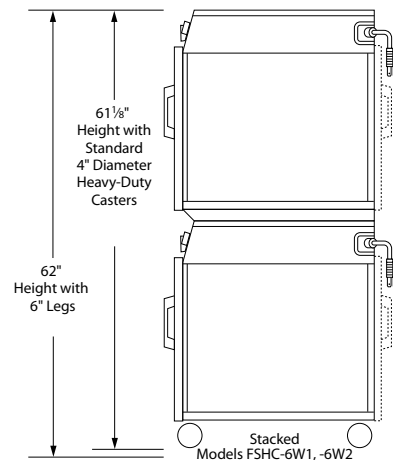
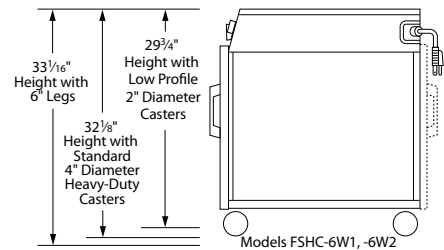

ONE (1) YEAR ON-SITE PARTS AND LABOR WARRANTY, PLUS ONE (1) ADDITIONAL YEAR PARTS-ONLY WARRANTY ON ALL FLAV-R-SAVOR® METAL-SHEATHED AIR HEATING ELEMENTS.

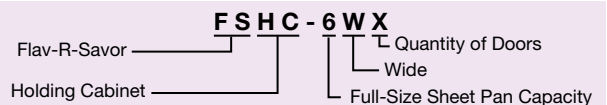

Flav-R-Savor® Humidified Portable Holding Cabinets

Prepare food in advance of peak serving periods and safely hold it at optimum serving temperatures with the Flav-R-Savor® Portable Holding Cabinet. Thermostatically-controlled heat and humidity allows you to hold product for hours.

- Thermostatically-controlled heat and humidity holds hot food at optimum serving temperatures longer

- Allows preparation of food in advance of peak serving periods
- Accommodates Gastronorm pans
- Electrical components, controls, water reservoir and digital temperature readout are located at the top for easy access
- Insulated side walls, field reversible glass doors, large swivel casters with wheel locks and a 6' recessed cord & plug set are standard
- Stacking kit available



FSHC-7-1 with standard 4" casters and accessory food pans

PORTABLE HOLDING CABINETS – HUMIDIFIED

Model	Description	Dimensions (W x D x H) <i>Height includes standard casters</i>	Plug	Ship Weight
FSHC-7-1	1 Door	22 ³ / ₄ " x 29 ⁵ / ₈ " x 35 ¹ / ₈ "	NEMA 5-15P	175 lbs.
FSHC-7-2*	2 Doors	22 ³ / ₄ " x 32" x 35 ¹ / ₈ "	NEMA 5-15P	180 lbs.

* FSHC-7-2 is a two-door pass-through single cabinet, not two units stacked.

All Portable Cabinet Models Feature:

Voltage: 120, 60 Hz, 1697 watts, 14.1 amps, NEMA 5-15P (Canadian models use NEMA 5-20P).

Cabinet Opening Dimensions: 18¹/₂"W x 22"H.

Top Surface Dimensions: 22³/₄"W x 25⁷/₈"D.

Models Shipped with: A 6' cord & plug set, 4" diameter casters (with 5¹/₈" clearance) and seven (7) sets of adjustable angle slides for 18" x 26" pans or 12" x 20" pans.

Pan Capacity: Seven (7) 18" x 26" sheet pans on 3" centers, seven (7) 20" x 12" x 2¹/₂" hotel pans or seven (7) 1/1 Gastronorm pans.

Water Tank Capacity for Humidity System: 3/4 gallon.

Cord Location: Back of unit, upper right side.

WATER QUALITY REQUIREMENTS – PAGE 19

OPTIONS (available at time of purchase only)

Colors (Side Panels) – Non-standard colors are non-returnable – Silver Gray Standard –

BLACK Designer Black

SS Stainless Steel

Colors (Top) – Non-standard colors are non-returnable – Silver Gray Standard –

BLACK Designer Black

SS Stainless Steel

SS-DR Stainless Steel Door in lieu of Glass Door

HD-SS-DR Heavy-Duty Stainless Steel Door with Positive Latch Handle

LWALARM Audible Low-Water Alarm

LPCAST 2" Low Profile Casters in lieu of standard Casters (2" diameter with 3" clearance – overall height is 32³/₄")

4LEGS 4" Adjustable Legs in lieu of standard Casters

6SS 6" Stainless Steel Legs in lieu of standard Casters

7-1-STACK Silver Gray Stacking Hardware mounted to top of Cabinet for two (2) FSHC-7-1 units in lieu of Casters

CORDWIND Bracket for holding Cord during transport

ACCESSORIES (available for purchase at any time)

SLIDEWIRE Wire Shelf

FOOD PANS AND TRIVETS – PAGE 19

COLORS AND FINISHES – PAGE 19

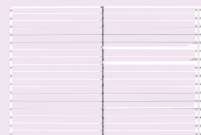

SLIDEWIRE
Accessory

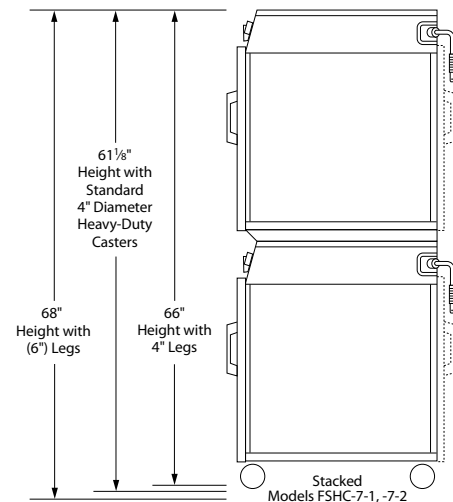
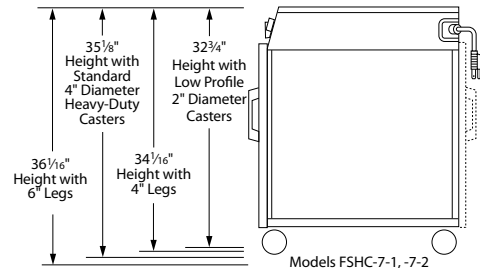

ONE (1) YEAR ON-SITE PARTS AND LABOR WARRANTY, PLUS ONE (1) ADDITIONAL YEAR PARTS-ONLY WARRANTY ON ALL FLAV-R-SAVOR® METAL-SHEATHED AIR HEATING ELEMENTS.

FSHC - 7 - X
Flav-R-Savor ———
Humidified ———
Holding Cabinet ———
Number of Doors ———
Quantity of Shelves ———



Flav-R-Savor® Tall Humidified Holding Cabinets

The expanded capacity of Hatco's Tall Humidified Cabinets offers flexibility – giving customers more variety of menu items, and holding larger quantities of proven favorites ahead of peak serving periods.

The universal slides of the FSHC-17W models will hold seventeen (17) sheet pans, or thirty-four (34) steam table pans. FSHC-12W models will hold twelve (12) sheet pans and twenty-four (24) steam table pans.

- Electronic controls with digital readout temperature range of 80°-200°F with precise heat and humidity settings assure uniform heating throughout the cabinet
- Using the lower temperature range of 80°-100°F allows perfect temperature for proofing all types of bread
- Lexan® or stainless steel doors, full height, half height and pass through available
- All stainless steel interior and exterior
- Fully insulated doors, sidewalls, base and top assist in heat retention and quick recovery
- Field reversible, right- or left-hand hinged doors with magnetic latch and heavy-duty plated hinges
- Fully welded tubular frame assures integrity of unit in any working environment



FSHC-12W1
with optional
Stainless Steel door



FSHC-17W1

TALL HUMIDIFIED HOLDING CABINETS

Model	Description	Dimensions W x D x H*	Voltage		Watts	Amps	Plugs	Ship Weight
			Single Phase					
FSHC-12W1	Single Lexan® Door	26" x 34¾" x 57¾"	120	1650	13.8	NEMA 5-15P [▲]	303 lbs.	
			208-240	1608-2133	7.7-8.9	NEMA 6-15		
FSHC-12W2	2 Lexan® Doors – Pass-Through	26" x 35¾" x 57¾"	120	1650	13.8	NEMA 5-15P [▲]	316 lbs.	
			208-240	1608-2133	7.7-8.9	NEMA 6-15		
FSHC-17W1	Single Lexan® Door	26" x 34¾" x 73¾"	120	1650	13.8	NEMA 5-15P [▲]	352 lbs.	
			208-240	1608-2133	7.7-8.9	NEMA 6-15		
FSHC-17W1D	Single Opening w/ 2 Dutch Doors	26" x 34¾" x 73¾"	120	1650	13.8	NEMA 5-15P [▲]	340 lbs.	
			208-240	1608-2133	7.7-8.9	NEMA 6-15		
FSHC-17W2	2 Lexan® Doors – Pass-Through	26" x 35¾" x 73¾"	120	1650	13.8	NEMA 5-15P [▲]	340 lbs.	
			208-240	1608-2133	7.7-8.9	NEMA 6-15		
FSHC-17W2D	4 Dutch Doors – Pass-Through	26" x 35¾" x 73¾"	120	1650	13.8	NEMA 5-15P [▲]	389 lbs.	
			208-240	1608-2133	7.7-8.9	NEMA 6-15		

- Height includes standard casters.
- ▲ Canadian models use NEMA 5-20P.

All Tall Humidified Holding Cabinet Models Feature:

Cabinet Opening Dimensions: FSHC-12W: 22"W x 43½"H.

FSHC-17W: 22"W x 59¾"H.

Models Shipped with: A 10' cord & plug set, 5" casters and universal slides for 18" x 26" pans or 12" x 20" pans.

Pan Capacity – FSHC-12W: 12-sheet pan capacity on 3" centers, adjustable on 1½" centers, with twelve (12) universal pan slides designed to accommodate up to twelve (12) sheet pans or up to twenty-four (24) steam table pans.

Pan Capacity – FSHC-17W: 17-sheet pan capacity on 3" centers, adjustable on 1½" centers, with seventeen (17) universal pan slides designed to accommodate up to seventeen (17) sheet pans or up to thirty-four (34) steam table pans.

Water Reservoir Capacity for Humidity System: 2 gallons.

Cord Location: Facing controls, right-hand side panel, lower right corner.

OPTIONS AND ACCESSORIES – PAGE 17

WATER QUALITY REQUIREMENTS – PAGE 19

ONE (1) YEAR ON-SITE PARTS AND LABOR WARRANTY, PLUS ONE (1) ADDITIONAL YEAR PARTS-ONLY WARRANTY ON ALL FLAV-R-SAVOR® METAL-SHEATHED AIR HEATING ELEMENTS.

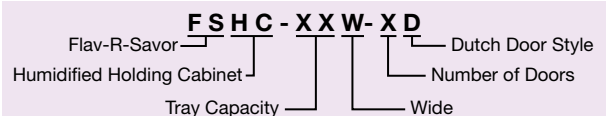



FSHC-17W1

OPTIONS (available at time of purchase only)

DELUXE	Deluxe Package (includes Flush Mount Handles and Full Perimeter Bumper)
TRANS	Transport Package (includes Stand-Off Handles, Full Perimeter Bumper, Heavy-Duty 5" x 2" Casters [two {2} swivel with wheel locks and two {2} rigid] and Flush Mount Transport Latch)
CORDUP	Upper Cord Location
CORDWIND	Bracket for holding Cord during transport (only available with Transport Package option for FSHC-12W and FSHC-17W models)
12W-SS-DOOR	Stainless Steel Door in lieu of Lexan® Door for FSHC-12W models
17W-SS-DOOR	Stainless Steel Door in lieu of Lexan® Door for FSHC-17W models
17WD-SS-DOOR	Stainless Steel Dutch Doors in lieu of Lexan® Dutch Doors for FSHC-17W models only

ACCESSORIES (available for purchase at any time)

17W-SLIDE	Extra Pan Slides (FSHC-12W and FSHC-17W models)
------------------	---

FOOD PANS AND TRIVETS – PAGE 19

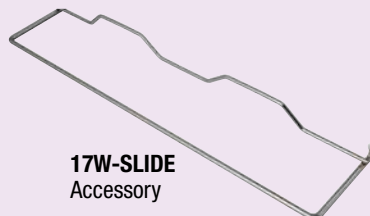

17W-SLIDE
Accessory



Flav-R-Savor® Heated Air Curtain Cabinets

The patented Flav-R-Savor® Heated Air Curtain Cabinet effectively and safely holds hot food hot without the use of doors, allowing immediate access to product. Warm air at the front of the cabinet is forced downward, through the ducts above the opening, forming a “curtain” of heated air. A portion of the heated air is drawn toward the rear of the cabinet, warming each pan.

- Perfect for holding wrapped or sealed product like tortillas, burritos and ribs, as well as product on sheet pans like biscuits, hamburger patties and baked potatoes or fried foods in pans
- Available in 2-pan and 3-pan models, single opening or pass-through, with or without humidity
- Standard units hold one half-size sheet pan per shelf, and the 2-pan pass-through accommodates two full-size sheet pans
- Easy to use digital controls, a lighted On/Off switch and a 6' cord & plug set



FSHACH-2 with accessory food pans



FS2HAC-2PT with accessory food pans

HEATED AIR CURTAIN CABINETS

Model	Description	Dimensions (W x D x H) <i>Height includes 4" legs</i>	Cabinet Opening Dimensions (W x H)	Voltage	Watts	Amps	Plugs	Ship Weight
FSHAC-2	2-Tier Warmer	20 ⁷ / ₈ " x 22 ⁷ / ₈ " x 18 ¹ / ₈ "	18 ¹ / ₄ "W x 9 ¹ / ₈ "H	120	1850	15.4	NEMA 5-20P	100 lbs.
FSHAC-2	2-Tier Warmer	20 ⁷ / ₈ " x 22 ⁷ / ₈ " x 18 ¹ / ₈ "	18 ¹ / ₄ "W x 9 ¹ / ₈ "H	120/208	1877	9.0	NEMA L14-20	100 lbs.
FSHAC-3*	3-Tier Warmer	20 ⁷ / ₈ " x 22 ⁷ / ₈ " x 30 ¹ / ₂ "	18 ¹ / ₄ "W x 18 ¹ / ₈ "H	120/208	1877	9.0	NEMA L14-20	115 lbs.
FS2HAC-2PT	2-Tier Pass-Through	24 ¹ / ₈ " x 39 ¹ / ₈ " x 18 ¹ / ₂ "	18 ¹ / ₈ "W x 8 ¹ / ₈ "H	120/208, 120/240	2589	10.8	NEMA L14-20	175 lbs.
FS2HAC-4PT	4-Tier Pass-Through	24 ¹ / ₈ " x 39 ¹ / ₈ " x 26 ¹ / ₂ "	18 ¹ / ₈ "W x 16 ¹ / ₈ "H	120/208, 120/240	3389	14.2	NEMA L14-20	211 lbs.

All Heated Air Curtain Cabinet Models Feature:

Cord Location: FSHAC-2, -3: Top of unit towards the back, middle.
FS2HAC-2PT, -4PT: Top of unit towards the back, left side.

HEATED AIR CURTAIN CABINETS – HUMIDIFIED

Model	Description	Dimensions (W x D x H) <i>Height includes 4" legs</i>	Cabinet Opening Dimensions (W x H)	Voltage	Watts	Amps	Plugs	Ship Weight
FSHACH-2	2-Tier Warmer	20 ⁷ / ₈ " x 24 ³ / ₈ " x 18 ¹ / ₈ "	18 ¹ / ₄ "W x 9 ¹ / ₈ "H	120/208	2950	14.2	NEMA L14-20	100 lbs.
FSHACH-3*	3-Tier Warmer	20 ⁷ / ₈ " x 24 ³ / ₈ " x 30 ¹ / ₂ "	18 ¹ / ₄ "W x 18 ¹ / ₈ "H	120/208	2950	14.2	NEMA L14-30	115 lbs.
FSHACH-2PT	2-Tier Pass-Through	24 ¹ / ₈ " x 35 ⁵ / ₈ " x 18"	18 ¹ / ₄ "W x 9 ¹ / ₄ "H	120/208	4952	23.8	NEMA L14-30	150 lbs.
FSHACH-2PT	2-Tier Pass-Through	24 ¹ / ₈ " x 35 ⁵ / ₈ " x 18"	18 ¹ / ₄ "W x 9 ¹ / ₄ "H	208	4952	23.8	NEMA L6-30P	150 lbs.

All Humidified Heated Air Curtain Cabinet Models Feature:

Models Shipped with: Auto-fill water reservoir and water filter.
Water Tank Capacity for Humidity System: FSHACH-2, -3: 2¹/₄ gallons.
FSHACH-2PT: 3 gallons.
Cord Location: FSHACH-2, -3: Top of unit towards the back, middle.
FSHACH-2PT: Top of unit towards the back, left side.

ACCESSORIES (available for purchase at any time)

4"LEGS 4" Legs (standard on 3-tier models)

FOOD PANS AND TRIVETS – PAGE 19
COLORS AND FINISHES – PAGE 19

ONE (1) YEAR ON-SITE PARTS AND LABOR WARRANTY, PLUS ONE (1) ADDITIONAL YEAR PARTS-ONLY WARRANTY ON ALL FLAV-R-SAVOR® METAL-SHEATHED AIR HEATING ELEMENTS.

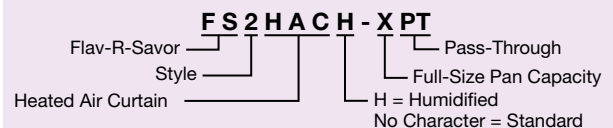

Food Pans And Trivets



FOOD PANS

Model	Description
ALUM PAN	Half-Size Sheet Pan – 18"W x 13"D
18"SHEET PAN	Full-Size Sheet Pan – 18"W x 26"D
14"PIZZA PAN	Perforated Pizza Pan – 14" Diameter
16"PIZZA PAN	Perforated Pizza Pan – 16" Diameter
18"PIZZA PAN	Perforated Pizza Pan – 18" Diameter
ST PAN 1/3	Third-Size Stainless Steel Pan – 12 $\frac{3}{4}$ "W x 6 $\frac{7}{8}$ "D x 2 $\frac{1}{2}$ "H
ST PAN 1/2	Half-Size Stainless Steel Pan – 12 $\frac{3}{4}$ "W x 10 $\frac{3}{8}$ "D x 2 $\frac{1}{2}$ "H
ST PAN 2	Full-Size Stainless Steel Pan – 12 $\frac{3}{4}$ "W x 20 $\frac{3}{4}$ "D x 2 $\frac{1}{2}$ "H
ST PAN 4	Full-Size Stainless Steel Pan – 12 $\frac{3}{4}$ "W x 20 $\frac{3}{4}$ "D x 4"H

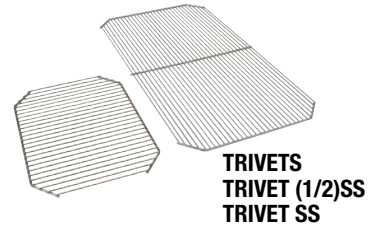

TRIVETS

Model	Description
Wire Trivets Stainless –	
TRIVET (1/2)SS	Half-Size – 10 $\frac{3}{16}$ "W x 7 $\frac{5}{8}$ "D
TRIVET SS	Full-Size – 10 $\frac{1}{8}$ "W x 18"D

Water Quality Requirements

Water supply in excess of 3.0 grains of hardness per gallon (GPG) must be treated and softened before being used. Water containing over 3.0 GPG will decrease the efficiency and reduce the operating life of the unit.

NOTE: Product failure caused by liming or sediment buildup is not covered under warranty.

Paint Chip Sample Colors

DESIGNER COLORS

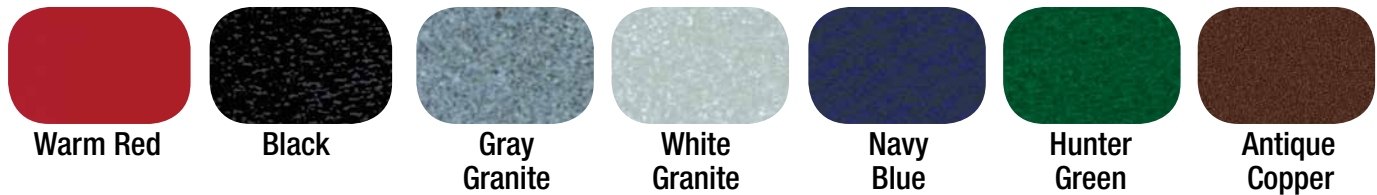

Colors are a representation and may not exactly match our colors. Consult factory for possible color matching options on these colors. Non-standard colors are non-returnable.

To order a Hatco Paint Chip & Stone Sample Colors Sheet, visit www.hatcocorp.com / Order Literature / Sales Literature / Sell Sheets.

Sturgeon Bay, WI 54235 U.S.A. Telephone: (800) 558-0607 or (414) 671-6350 hatcocorp.com



Scan with web-enabled
mobile device to visit
www.hatcocorp.com

Hatco Corporation

P.O. BOX 340500 | Milwaukee, WI 53234-0500 USA

800-558-0607 | 414-671-6350

www.hatcocorp.com | support@hatcocorp.com